

Name	Charlotte	A
Typology	Chaise longue	
Designer	Christophe de la Fontaine	



Description	An aluminium chaise longue with a removable leather mattress and adjustable head-rest. An extremely compact reinterpretation of a well known classic, available in both polished and powder coated finish, as well as various colors of leather. The construction-free mattress, even though giving an impression of a defined curve has a free flow, adjusting its form to the body's natural position.
--------------------	--

Name Charlotte B

Material Split leather, Leather thema, Powder-coated, textured or anodized aluminum

Examples



07.1
09.1
18.1



07.1
09.3
18.1



07.6
09.6
16.6

Name	Charlotte	C
-------------	------------------	----------

Material	Split leather	07
-----------------	----------------------	-----------

Colours	07.1	white
----------------	-------------	--------------

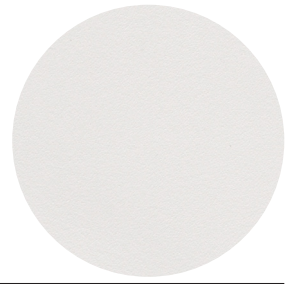

07.2	tan
-------------	------------



07.3	dark brown
-------------	-------------------



07.4	bordeaux
-------------	-----------------









07.5	dark grey
-------------	------------------



07.6	black
-------------	--------------



Name	Charlotte		C
Material	Leather thema		09
Colours	09.1	white	
	09.2	yellow	
	09.3	nude	
	09.4	peach	
	09.5	tan	
	09.6	cognac	
	09.7	bordeaux	

Name Charlotte C

Material Leather thema 09

Colours 09.8 dark green

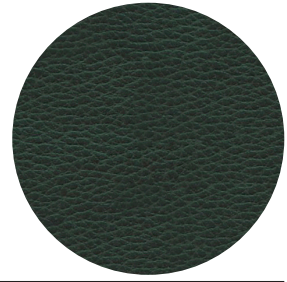

09.9 grey



09.10 black



Name	Charlotte	0
-------------	------------------	----------

Material	Powder-coated, textured aluminum	16
-----------------	---	-----------

Colours	16.1	white
----------------	-------------	--------------



Colours	16.6	black
----------------	-------------	--------------



Material	Anodized aluminum	17
-----------------	--------------------------	-----------

Colours	18.1	metal silver
----------------	-------------	---------------------



Name

Charlotte



Dimensions

145 x 50 x 90cm

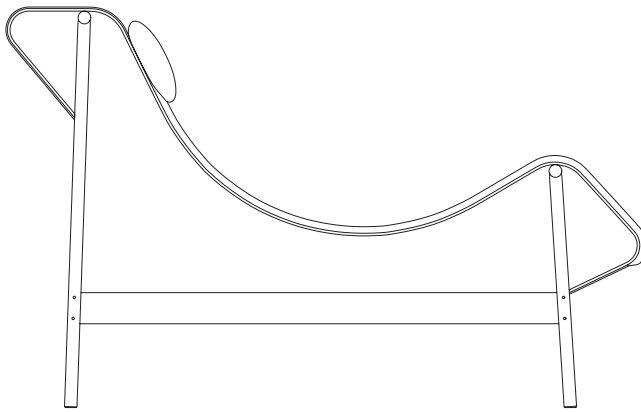
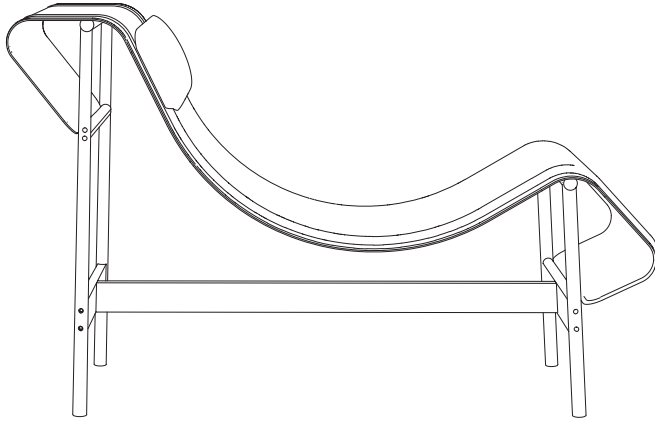

145

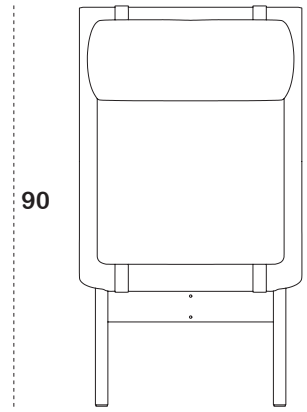

90

50